

Totally Bralco

BRALCO
YOUR SMART ITALIAN OFFICE

totally Bralco

1 lux
design: Arch. Gianantonio Perin & Monica Fernandes
pag. 4-7

2 concerto
design: Arch. Gianantonio Perin & Monica Fernandes
pag. 8-11

3 glt
design: Arch. Gianantonio Perin & Giorgio Topan
pag. 12-15

4 take-off evolution
design: Arch. Gianantonio Perin & Monica Fernandes
pag. 16-19

5 3° livello
design: Arch. Gianantonio Perin & Monica Fernandes
pag. 20-23

6 kubick
pag. 24-27

7 winglet®
design: r&d Bralco
pag. 28-31

8 domomag
design: Arch. Renato Fornaciari & Francesco Fait
pag. 32-35

9 rail
design: Arch. Gianantonio Perin & Giorgio Topan
pag. 36-39

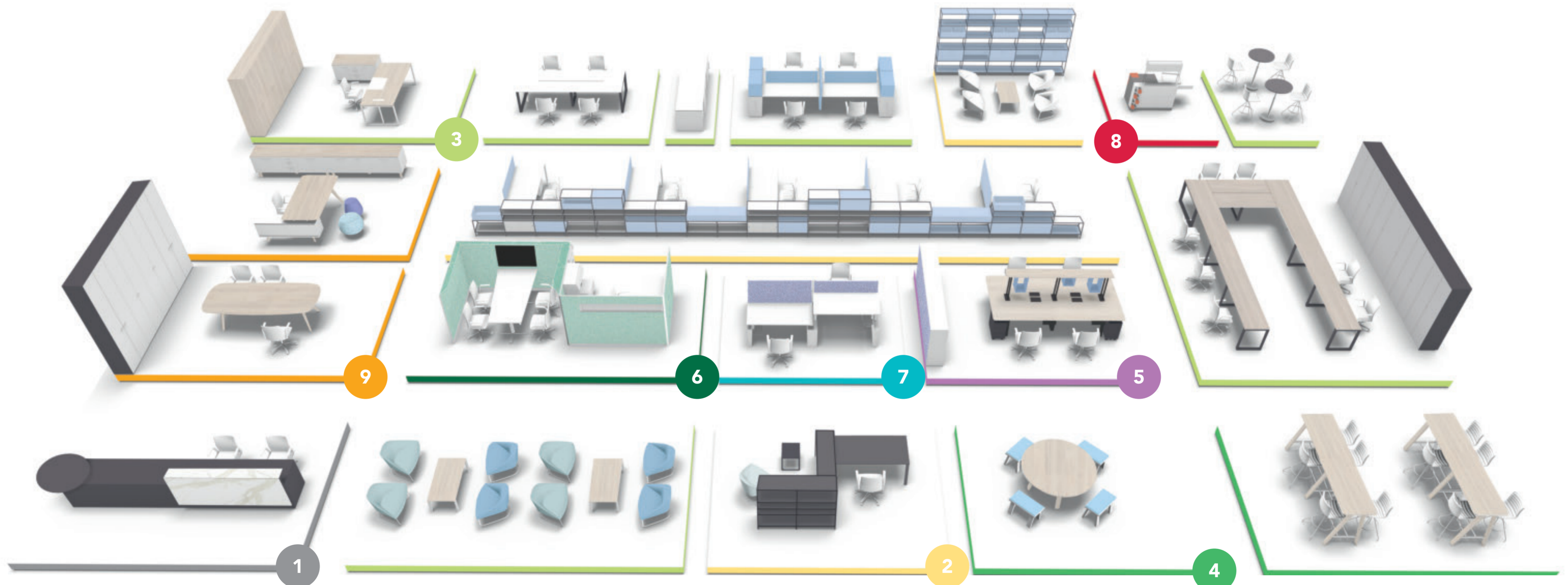

lux

reception minimalist

design: Arch. Gianantonio Perin & Monica Fernandes



Luce e minimalismo per un'elegante accoglienza.

Light and refined for an elegant welcome.

Lumière et minimalisme pour un accueil élégant.

Edler Empfang dank Licht und Minimalismus.

Licht en verfijnd voor een aangenaam ontvangst.

Luz y minimalismo para una recepción elegante.

modularity & materials



intensità luce regolabile
adjustable light intensity
intensité lumineuse réglable
einstellbare Lichtstärke
dimbare lichtsterkte
intensidad de luz regulable



numerosa finiture
numerous fine finishes
nombreuses finitions
zahlreiche Oberflächen
verschillende afwerkingen
numerosos acabados



mensole su posizioni personalizzate
custom location of the front module risers
étagères avec positions personnalisables
individuell einsetzbare Aufsätze
aanpasbare frontmodule
repisas con posiciones que se pueden personalizar



mensola per oratore
lectern module riser
étagère pour opérateur
rednerpult
lessenaar module
repisa para orador

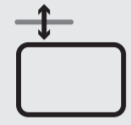

piano elevabile
height adjustable desk top
plateau réglable en hauteur
höhenverstellbare Platte
hoogteverstelbaar bureaublad
tapa que se puede elevar



passaggio cavi ed elettrificazione integrati
channels for cables & wires
integrated electrifying equipment
passage de câbles et électrification intégrés
integrierte Kabelführung und Elektrifizierung
openingen voor bekabeling en inbouw dataunits
pasacables y electrificación integrable

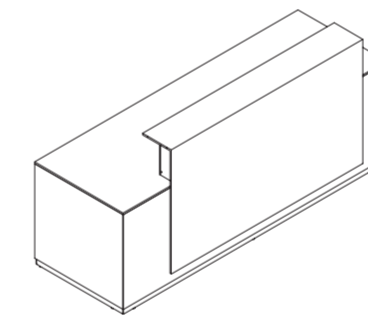

bancone con singolo frontale
reception counter complete with single front
banque d'accueil avec façade simple
theke mit Einzelfront
complete balie met enkel front
mostrador con unico frontal

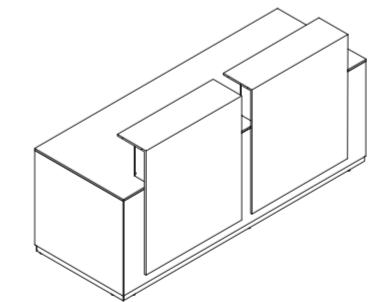

bancone con doppio frontale
reception counter complete with double front
banque d'accueil avec façade double
theke mit Doppelfront
complete balie met dubbel front
mostrador con doble frontal

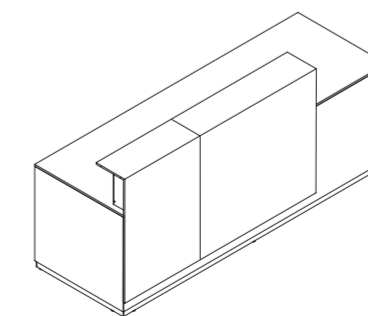

bancone a parete
wall side reception counter
banque d'accueil côté mur
theke mit Wandanschluss
balie muurzijde
mostrador a pared

concerto

integrated storage working system

design: Arch. Gianantonio Perin & Monica Fernandes



**La leggerezza di un sistema modulare e personalizzabile
per un nuovo concetto dell'ambiente di lavoro.**

The lightness of a modular and flexible system designed
as a new concept for the working space.

La légèreté d'un système modulaire et personnalisable
pour un nouveau concept de l'espace du travail.





Arbeitsplätze mit Leichtigkeit durch ein flexibles
Modulsystem neu konzipieren.

De eenvoud van een modulair en flexibel systeem ontworpen
voor de werkkruimte.

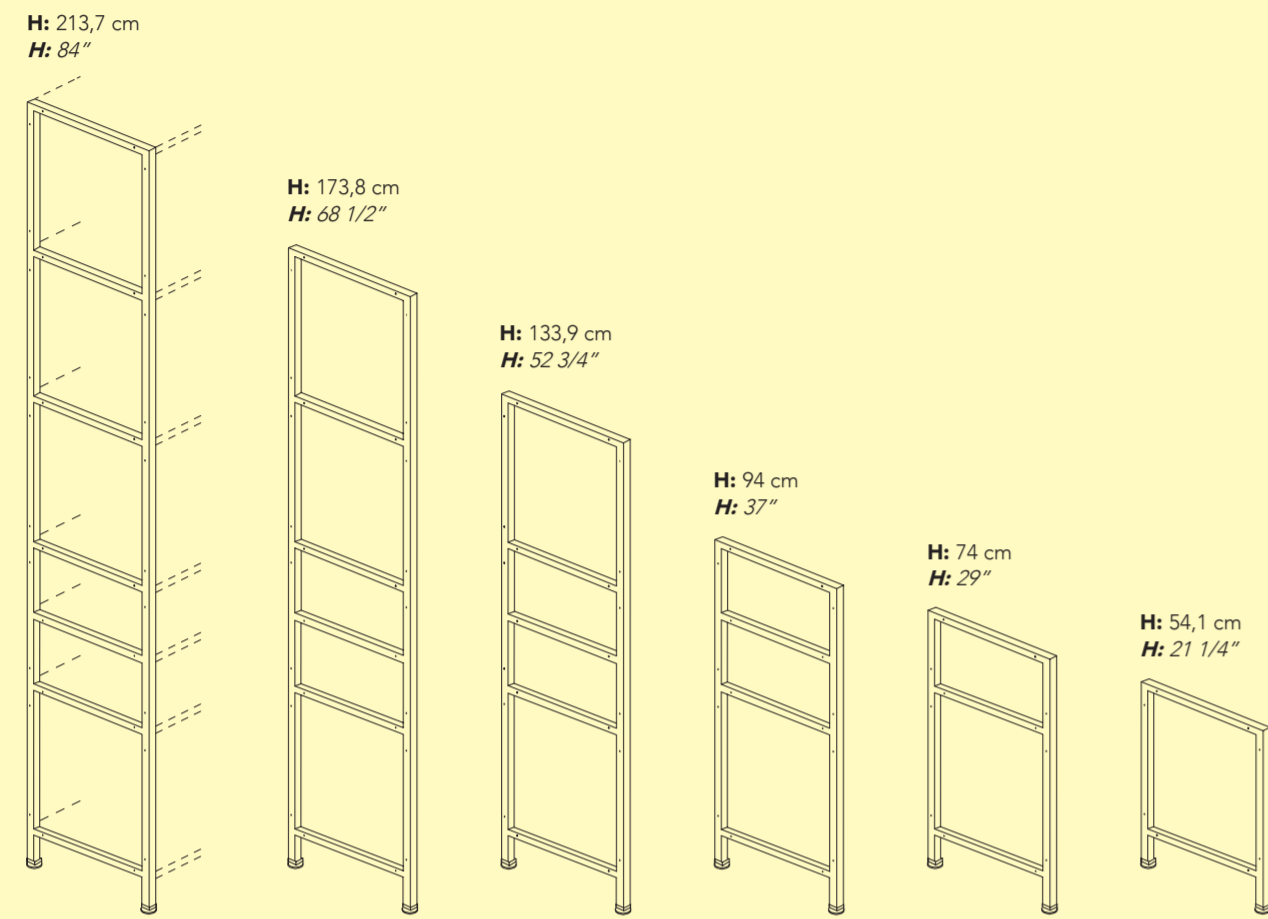
La ligereza de un sistema modular y personalizable
para un nuevo concepto del ambiente de trabajo.

easily adaptable



- | | | | | |
|--|--|--|---|---|
|  |  |  |  |  |
| ripiano metallico
metal shelf
étagère en métal
regal aus Metall
metalen plank
estante de metal | schiena
back
dos
rückwand
achterwand
respaldo | ubi | cuscino
cushion
cousin
sitzpöster
kussen
cojin | contenitore
container
réipient
behälter
houder
contenedor |
| W: 36-80 cm, W: 14"-31 1/2"
D: 40 cm, D: 15 3/4"
H: 2 cm, H: 0 3/4" | W: 80 cm, W: 31 1/2"
D: 2 cm, D: 0 3/4"
H: 37,7 cm, H: 14 3/4" | W: 80 cm, W: 31 1/2"
D: 40 cm, D: 15 3/4"
H: 39,8 cm, H: 15 3/4" | W: 80 cm, W: 31 1/2"
D: 40 cm, D: 15 3/4"
H: 20 cm, H: 7 3/4" | W: 80 cm, W: 31 1/2"
D: 40 cm, D: 15 3/4"
H: 10 cm, H: 4" |

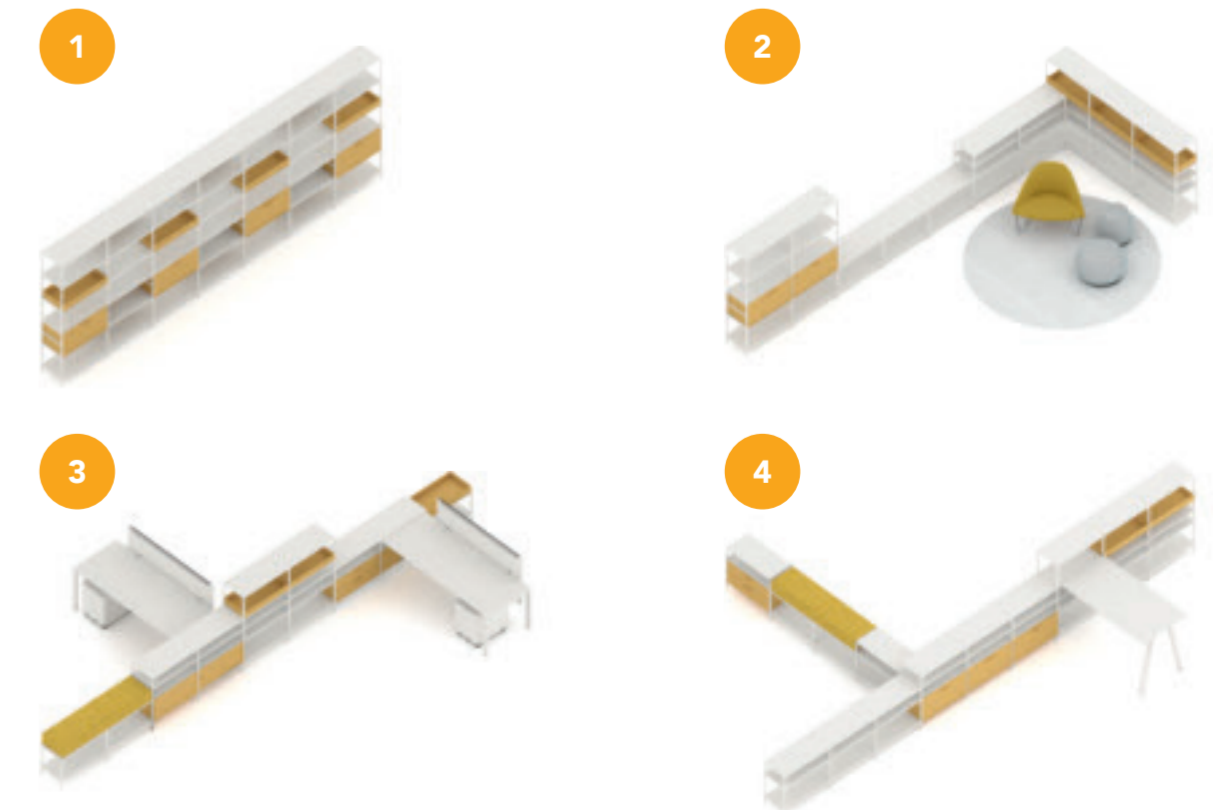

changing style

design: Arch. Gianantonio Perin & Giorgio Topan



Sistema trasversale che interpreta tutti gli ambienti ufficio.

An Adaptable system that caters for all working spaces.

Système transversal qui interprète tous les ambiances de bureau.

Ein allumfassendes System sprengt herkömmliche Grenzen in Bürolandschaften.

Een flexibel systeem geschikt voor alle werkplekken.

Sistema transversal que interpreta todos los ambientes de la oficina.

for all offices

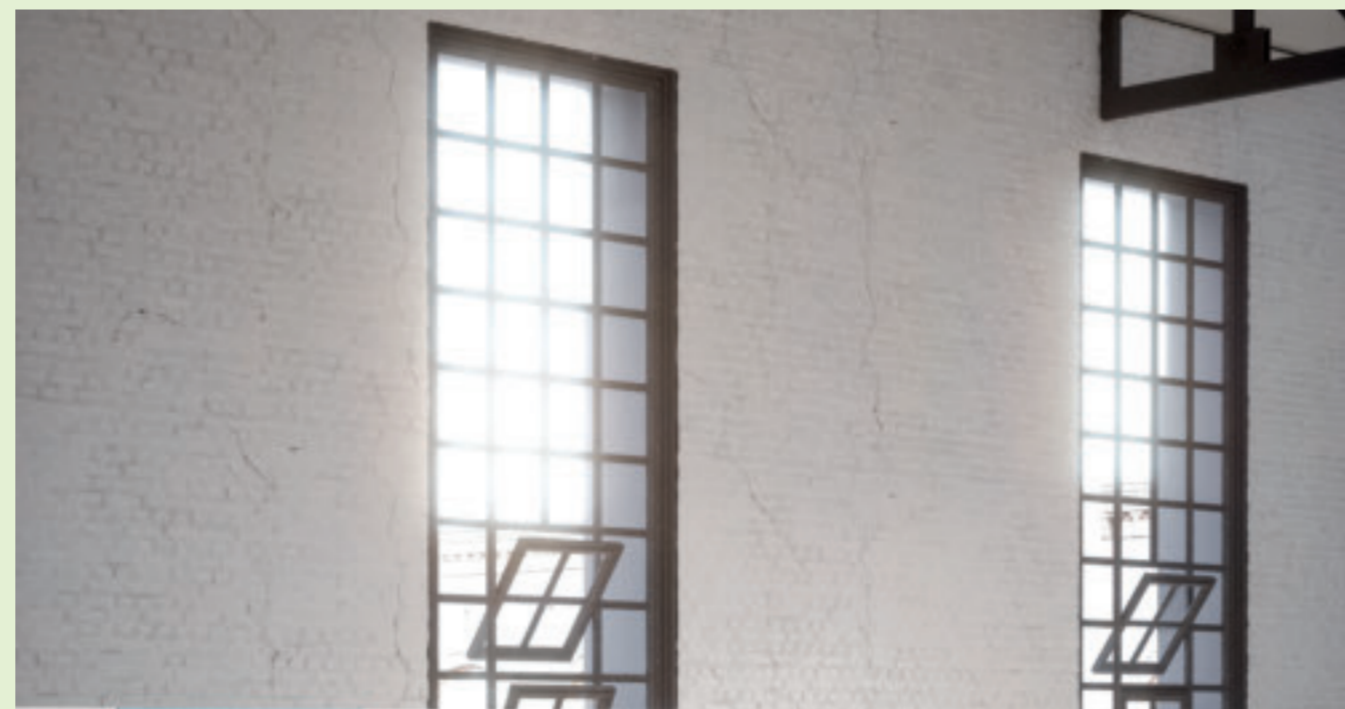

reception



operative



executive



meeting

take-off evolution

choose the finish

design: Arch. Gianantonio Perin & Monica Fernandes



Finiture tattili e materiche per uffici meno convenzionali con soluzioni ad alta interazione.

Tactile and alternative finishes for the more design led workstations complete with high interactive solutions.

Finitions tactiles et matérielles pour des bureaux moins conventionnels avec des solutions d'interaction élevées.

Material und Haptik sprengen die Grenzen konventioneller Büros und bieten Arbeitsplatzlösungen mit hoher Integration.

Fraaie alternatieve afwerkingen voor meer design werkplekken compleet met veel interactieve oplossingen.

Materiales que se pueden percibir las cualidades de sus acabados para oficinas menos convencionales con soluciones para interactuar el hombre con su medio (su puesto de trabajo).

many
finishing



evo

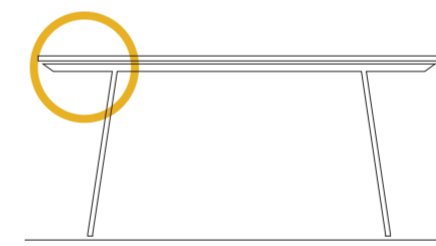

18 mm
3/4"

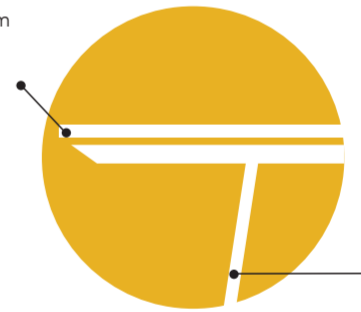

metallo
metal
métal
metall
metaal
metal

country

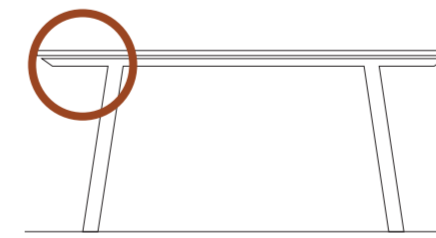

18 mm
3/4"

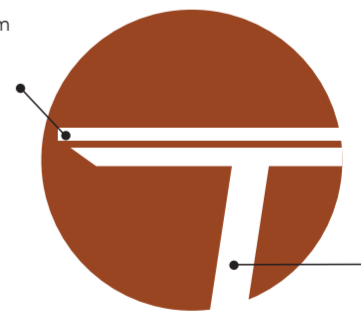

rivestito
coated
revêtu
beschichtete
bekleed
revestido

farm

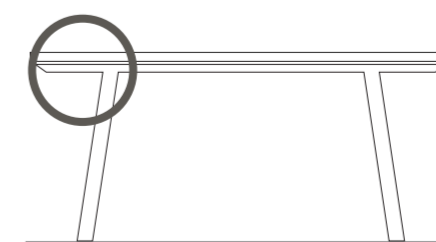

30 mm
1"

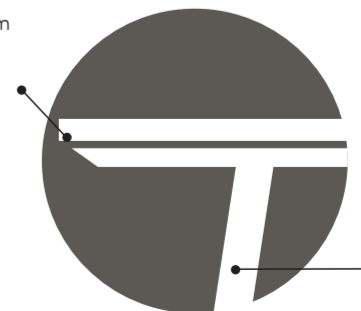

rivestito
coated
revêtu
beschichtete
bekleed
revestido

3° livello

choose the way

design: Arch. Gianantonio Perin & Monica Fernandes



La 3^a dimensione dei posti di lavoro.

Third level storage for a variation of working spaces.

La 3ème dimension de l'espace.

Die dritte Dimension am Arbeitsplatz.

Variatie in de werkruimte door derde niveau aflegruimte.

La 3º dimensión de puestos de trabajo.

choose
the height



ASL

armadi con ante scorrevoli, cabinets with sliding doors, armoires avec portes coulissantes, schranke mit Schiebetüren, kasten met schuifdeuren, armarios con puertas correderas

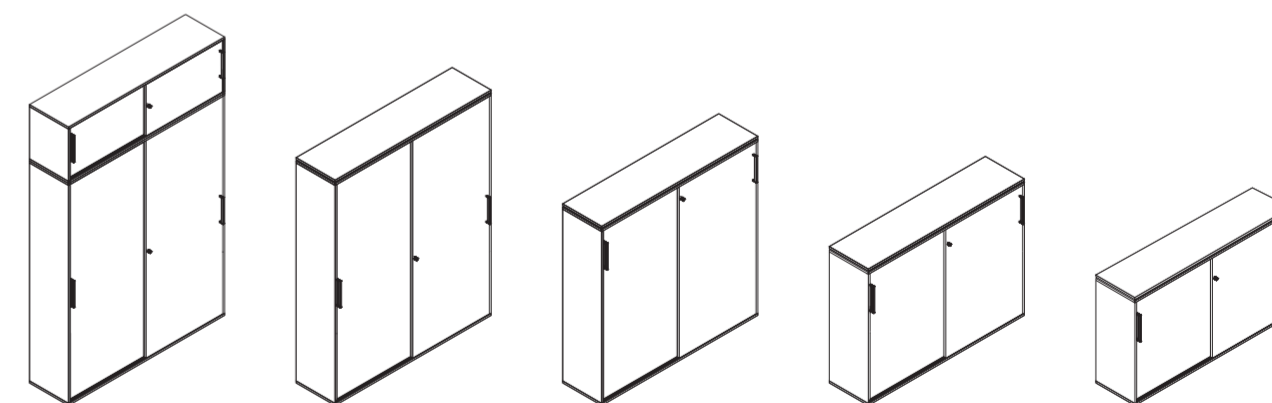

W: 120-160 cm
W: 47 1/4"-63"
D: 46 cm
D: 18"
H: 248,8 cm
H: 98"

W: 120-160 cm
W: 47 1/4"-63"
D: 46 cm
D: 18"
H: 195,8 cm
H: 77"

W: 120-160 cm
W: 47 1/4"-63"
D: 46 cm
D: 18"
H: 157,4 cm
H: 62"

W: 120-160 cm
W: 47 1/4"-63"
D: 46 cm
D: 18"
H: 119 cm
H: 46 3/4"

W: 120-160 cm
W: 47 1/4"-63"
D: 46 cm
D: 18"
H: 80,6 cm
H: 31 3/4"

kubick

create your own privacy



**Isole di lavoro nel rispetto della Privacy.
Spazi aperti ma protetti acusticamente e accessoriabili.**

Individual enclosed workstations within Open spaces.
Complete with added acoustic features and fully-equipped.

Ilots de travail dans le respect de la confidentialité.
Espaces ouverts mais protégés acoustiquement et accessorisés.

Eine Arbeitsinsel mit Schutz des Privatbereiches.
die Räume bleiben offen, bieten aber akustischen Schutz
und Komfort durch Accessoires.

Individuele gesloten werkplekken in de open ruimte.
compleet met makkelijk toepasbare akoestische elementen.

Islas de trabajo respetando la privacidad.
Espacios abiertos pero acústicamente protegidos
y donde se pueden poner accesorios.

many
configurations



Sistema per il passaggio cavi e per l'elettrificazione dei piani, Cables Management and electrification of the desk tops, Système pour le passage des câbles et pour l'électrification des plateaux, Kabelmanagement für Tischplatten, Kabelmanagement met transport via plinten, Sistema de paso de los cables y de electrificación de la tapa de la mesa.

- 1 **passaggio cavi elettrici attraverso lo zoccolo**, cables Management passage through plinths, passage des câbles électriques à travers la plinthe, kabeldurchlass am Sockel, kabelmanagement met transport via plinten, cavidad en el zocalo para pasar los cables.
- 2 **salita cavi attraverso il montante verticale**, cables Management passage through the vertical module, montée des câbles à travers le montant vertical, kabelaufgang, Kabelmanagement met transport via verticale module, subida de cables a traves del montante vertical.
- 3 **salita cavi attraverso canale**, cables passage through the cable duct, goulotte pour le logement des câbles, kabelaufgangskanal, Kabeltransport via kabeldoorvoer, subida de cables a traves de la canal.
- 4 **uscita cavi sul piano tramite top access**, cables exit on the desktop via a desk top access, sortie des câbles sur le plateau à travers le top accès, kabelausgang mit "Top Access", Kabeldoorlaat via bovenkant bureautafel, salida de cables a traves del acceso superior.



winglet®

sit stand working system

design: r&d Bralco



**Semplice, facile, riconfigurabile: tre misure,
una sola struttura telescopica.**

Simple, easy, adjustable: three measures,
one telescopic structure.

Simple, facile, riconfigurabile: trois dimensions,
une seule structure télescopique.

Schlicht, einfach, verwandelbar: drei Größen,
ein einziges teleskopisches Gestell.

Simpel, eenvoudig, verstelbaar: 3 maten,
één telescopisch onderstel.

Simple, fácil, reconfigurable: tres tamaños,
una sola estructura telescópica.



configure your desk

a system in compliance with European Standard
EN 527-1:2001



fissa
fixed
fixe
feststehend
vas
fija



manovella
crank
manivelle
kurbel
slinger
manivela

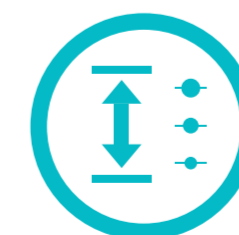

pulsante
push button
bouton poussoir
schalter
druknop
pulsador

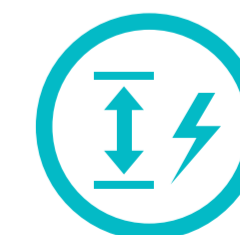

elettrica
electrical
électrique
elektrisch
elektrisch
eléctrico



domomag

modular integrable

design: Arch. Renato Fornaciari & Francesco Fait



**Mobile, compatta e configurabile:
l'interpretazione della cucina integrata all'area di lavoro.**

Mobile, compact, and reconfigurable:
the interpretation of the kitchen integrated within the workspace.

Mobile, compact et configurable:
l'interprétation de la cuisine intégrée à l'espace du travail.

Mobil, kompakt, individuell zu gestalten:
eine Küchenlösung, konzipiert für die Integration in eine Bürolandschaft.

Verrijdbaar, compact, herindeelbaar:
het antwoord op een pantry-keuken binnen de werkruimte.

Movable, compacta y configurable:
la interpretación de la unidad de cocina para el espacio del trabajo.

perfectly
integrated



composizioni su ruote, compositions on castors, compositions sur roulettes, compositionen auf Füßen, cëriijdbare compositie, composiciones sobre ruedas



W: 81 cm, W: 31 3/4"
D: 54 cm, D: 21 1/4"
H: 92 cm, H: 36 1/4"

W: 135 cm, W: 53"
D: 54 cm, D: 21 1/4"
H: 92 cm, H: 36 1/4"

W: 135 cm, W: 53"
D: 83,5 cm, D: 32 3/4"
H: 170 cm, H: 67"

moduli componibili, su piedini, modular storage, on feet, modules intégrés avec pieds, einbaumodule, auf Füßen, modulair opbergsysteem, op voetjes, modulos componibles, sobre patas

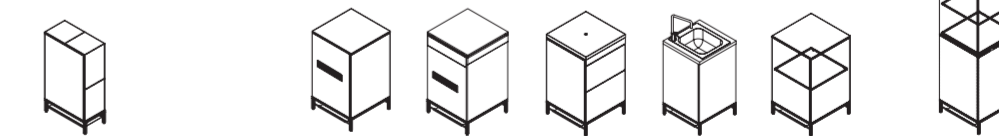

W: 27 cm, W: 10 3/4"
D: 54 cm, D: 21 1/4"
H: 92 cm, H: 36 1/4"

W: 54 cm, W: 21 1/4" x 21 1/4"
D: 54 cm, D: 21 1/4" x 21 1/4"
H: 92 cm, H: 36 1/4"

W: 54 cm, W: 21 1/4"
D: 54 cm, D: 21 1/4"
H: 106 cm, H: 41 3/4"

scaffale e pensili, shelf and wall unit, étagère et meuble suspendu, regal und Wandmodul, plank met opknoping, estantería y armario de pared

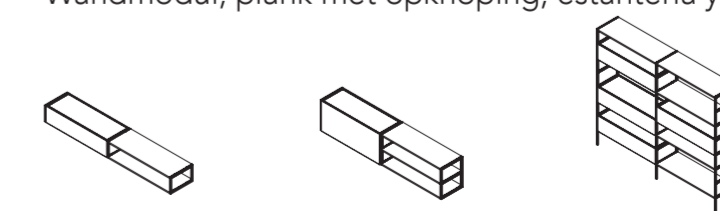

W: 202 cm, W: 79 1/2"
D: 36 cm, D: 14"
H: 23 cm, H: 9"

W: 202 cm, W: 79 1/2"
D: 36 cm, D: 14"
H: 44 cm, H: 17 1/4"

W: 202 cm, W: 79 1/2"
D: 36 cm, D: 14"
H: 170 cm, H: 67"

rail

shape of elegance

design: Arch. Gianantonio Perin & Giorgio Topan



Linee pure ed essenziali di un'assoluta eleganza formale.

Pure and essential lines for an absolute formal elegance.

Lignes pures et essentielles d'élégance formelle absolue.

Schlichte, schnörkellose Linienführung, Edle Eleganz.

Pure en essentiële lijnen voor absolute formele elegantie.

Líneas puras y esenciales de una elegancia formal absoluta.

essential design



managerial



meeting x3



managerial 1+1/2 guest

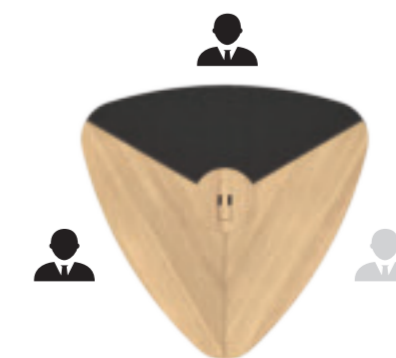

meeting x6

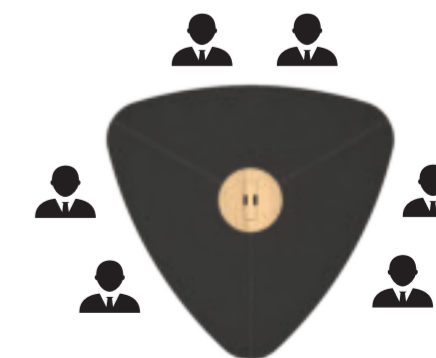

finishes

Legno (top, ante, fianchi, glt: schiena mobile), wood (top, doors, sides, glt: service unit back), bois (top, portes, flancs, glt: dos du meuble de service), holz (top, türen, seiten, glt: Rückwand von Servicemöbeln), hout (top, deurtjes, seiten, glt: rug de dienstmeubel), madera (top, puertas, costados, glt: trasera de mueble de servicio)

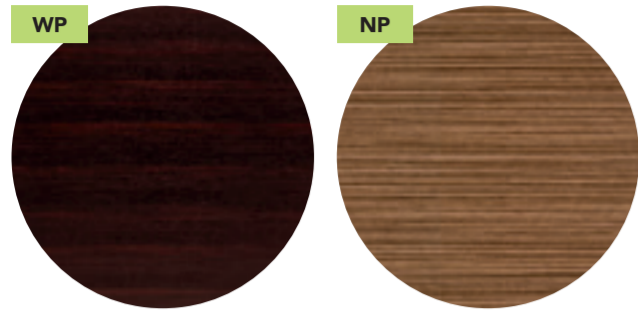

WP
wengè, wengè, wengè, Wengè,
wengè, wengè

NP
noce americano, american walnut, noyer
américain, Amerikanischer Nussbaum,
amerikaans notenhout, nogal americano

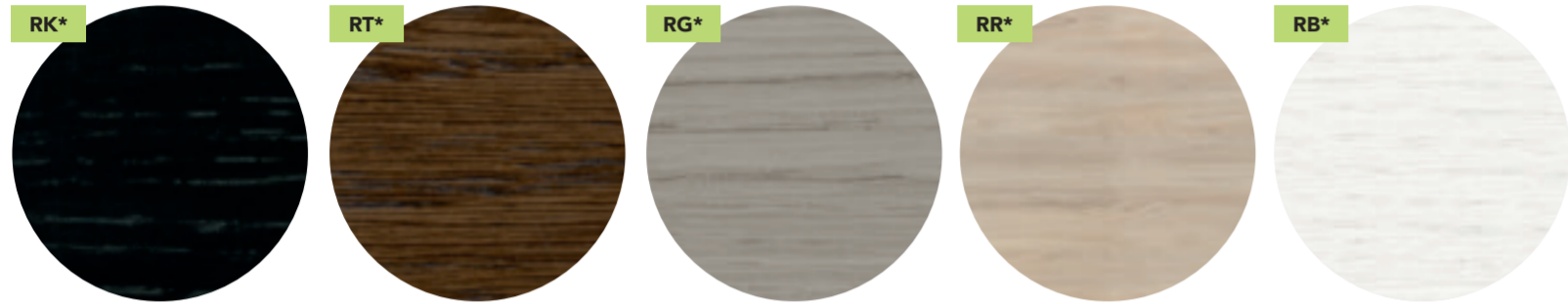

RK*
rovere laccato nero, black lacquered oak,
chêne laqué noir, Schwarz lackierter Eiche,
zwart gelakt eiken, roble lacado negro

RT*
rovere tabacco, tobacco oak, chêne
tabac, eiche Tabak, eikenhout tabak,
roble tabaco

RG*
rovere grigio, grey oak, chêne gris, eiche
grau, grijs eiken, roble gris

RR*
rovere naturale, natural oak, chêne
naturel, natur Eiche, eikenhout natuur,
roble natural

RB*
rovere laccato bianco, white lacquered oak,
chêne laqué blanc, Weiß lackierter Eiche, wit
gelakt eiken, roble lacado blanco

*rail: gambe, rail: legs,
rail: piètements, rail: beine,
rail: poten, rail: patas

vetroceramica (top, Lux: mensole), glass ceramic (top, Lux: shelves), vitroceramique (top, Lux: étagères murale), glaskeramik (top, Lux: wandregale), vitrokeramisch (top, Lux: planken), vitroceramica (top, Lux: estante de pared)

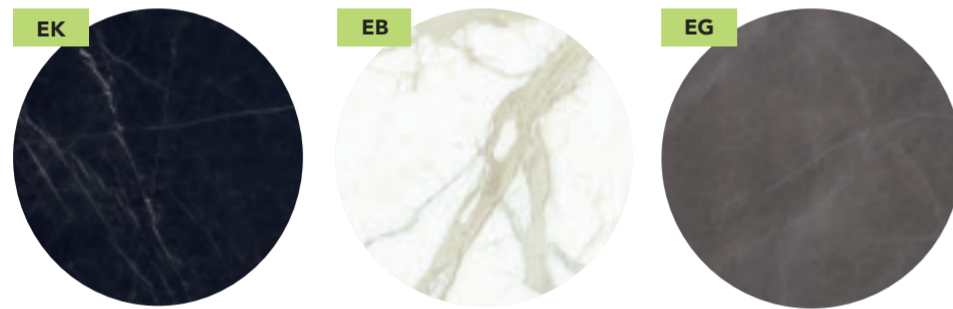

EK
nero marquinia opaco, marquinia black
matt, noir mat marquinia, schwarz matt
marquinia, zwart marquinia mat,
marquinia negro mate

EB
bianco calacatta lucido, glossy white
calacatta, blanc brillant calacatta, weiß
glänzend calacatta, glanzend wit calacatta,
calacatta blanco brillo

EG
grigio stone opaco, stone grey matt, gris
mat stone, grau matt stone, grijs stone
mat, gris mate stone

melaminico, melamine, mélamine, melamin, melamine, melamina

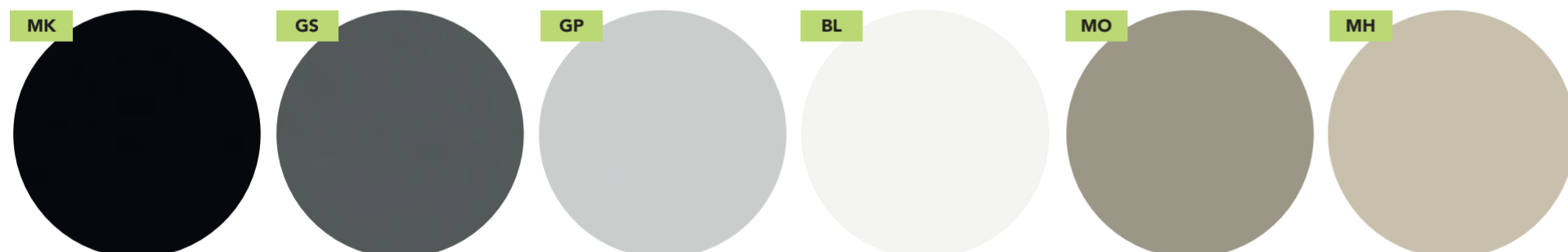

MK
nero, black, noir, Schwarz,
zwart, negro

GS
grigio granito, granite grey, gris granit,
granitgrau, granietgrijs, gris granito

GP
grigio perla, pearl grey, gris perle,
perlgrau, parelgrijs, gris perla

BL
bianco, white, blanc,
Weiß, wit, blanco

MO
tortora, turtledove, tourterelle,
Turteltaube, tortelduif, tórtola

MH
nebbia, mist, brouillard,
Nebelgrau, mist, niebla

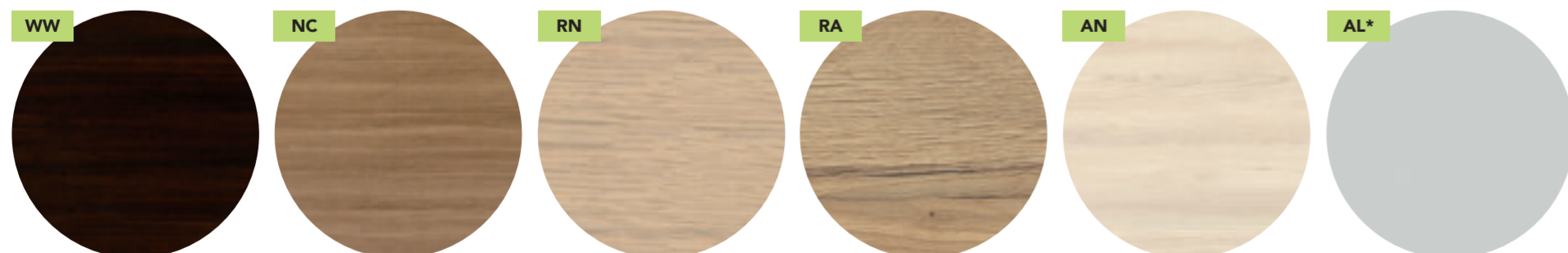

WW
wengè scuro, dark wengè, wengè
foucé, dunkel wengè, donker wengè,
wengè oscuro

NC
noce canaletto, canaletto walnut,
noyer canaletto, Canaletto nussbaum,
notenhou canaletto, nogal canaletto

RN
rovere naturale, natural oak,
chêne naturel, Nature eiche,
eikenhout natuur, roble natural

RA
rovere anticato, traditional oak, chêne
antique, Eiche antik, oud eiken decorme-
lamine, melamina roble antiguo

AN
acero champagne, champagne hard
maple, érable champagne,
Champagner-ahorn, esdoorn champagne,
arce champán

AL*
alluminio, aluminium, aluminium,
aluminium, aluminium, aluminio

*no piani, no tops,
no platten, no platten,
no werkbladen, no planos

fenix (top), fenix (top), fenix (top), fenix (top),
fenix (top), fenix (top)



HG
titanio 724
titanium 724
titan 724
titanium 724
titanio 724

HO
bianco
white
blanc
weiß
wit
blanco

HA*
acciaio hamilton
hamilton steel
acier hamilton
hamilton stahl
hamilton staal
acero hamilton

*solo Lux: mensole
*only Luxshelves
*seulement Lux: étagères murale
*nur Lux:wandregale
*alleen Lux:planken
*solo Lux:estante de pared

vetro temperato opaco (top, ante), tempered matt glass (top, doors), verre trempe opaque (top, portes), matt temperiertes glas (top, türen), mat gehard glas (top, deurtjes), vidrio templado mate (top, puertas)

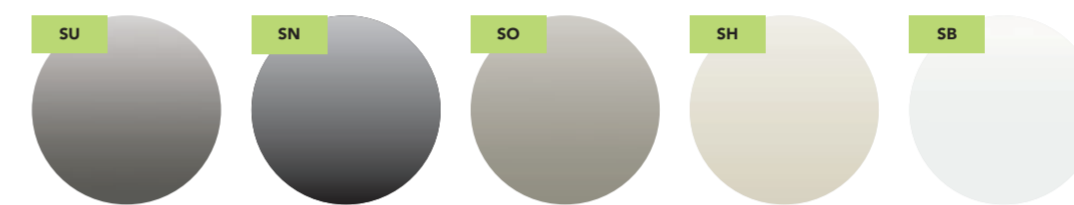

SU
titanio
titanium
titane
titan
titanium
titanio

SN
nero
black
noir
Schwarz
zwart
negro

SO
tortora
turtledove
tourterelle
turteltaube
tortelduif
tortola

SH
nebbia
mist
brouillard
Nebelgrau
mist
niebla

SB
bianco
white
blanc
Weiß
wit
blanco

vetro temperato (top, ante), tempered glass (top, doors), verre trempe (top, portes), temperiertes glas (top, türen), gehard glas (top, deurtjes), vidrio templado (top, puertas)

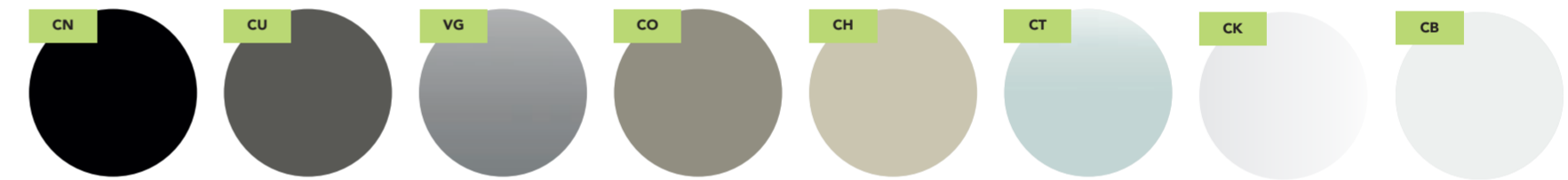

CN
nero
black
noir
Schwarz
zwart
negro

CU
titanio
titanium
titane
Titan
titanium
titanio

VG
grigio sp. 5mm
grey sp. 5 mm
gris sp. 5 mm
Grau sp. 5 mm
grijs sp. 5 mm
gris sp. 5 mm

CO
tortora
turtledove
tourterelle
Turteltaube
tortelduif
tórtola

CH
nebbia
mist
brouillard
Nebelgrau
mist
niebla

CT
satinato
frosted
satiné
mattier
gesatineers
satinado

CK
trasparente
transparent
transparentes
transparente
transparente

CB
bianco
white
blanc
Weiß
wit
blanco

metallo (struttura), metal (structure), métal (structure), metall (struktur), metaal (structuur), metal (estructura)

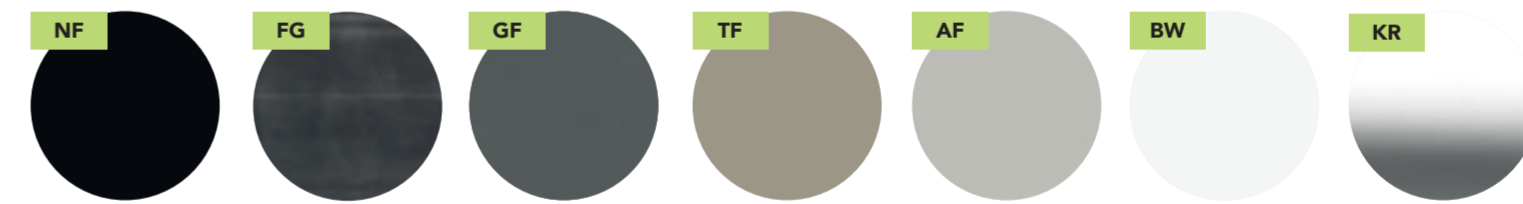

NF
nero
black
noir
schwarz
zwart
negro

FG
metallo crudo
raw metal
métal brut
rohes metall
onbehandeld metaal
metal toscó

GF
grigio granito
granite grey
gris granit
granitgrau
granietgrijs
gris granito

TF
tortora
turtledove
tourterelle
turteltaube
tortelduif
tórtola

AF
epox alluminio
silver epoxy
epoxy aluminium
aluminium
aluminiumkler geepoxerd
epoxidica de aluminio

BW
bianco
white
blanc
weiß
wit
blanco

KR
cromo lucido
glossy chrome
chrome brillant
chrom poliert
glazend verchroomd
cromo pulido

laccato opaco (no top), matt lacquered (no top), lacquè mat (no top), matt lackiert (no top), matgelakt (no top), laqueado mate (no top)

nero black noir schwarz zwart negro	titanio titanium titane titan titanium titanio	tortora turtledove tourterelle turteltaube tortelduif tortola	nebbia mist brouillard Nebelgrau mist niebla	alluminio aluminium aluminium aluminium aluminio	bianco white blanc weiß wit blanco	deep teal deep teal bleu canard deep teal deep teal deep teal	oceano ocean océan meerblau ocean oceano	verde muschio moss green vert mousse moosgrün mosgroen verde musgo
verde natura gras green vert nature grasgrün groene natuur verde naturaleza	bordeaux bordeaux bordeaux bordeaux bordeaux burdeos	giallo gold yellow gold jaune or goldgelb geelgouden oro amarillo						

metacrilato (ubi: ante scorrevoli), methacrylate (ubi: sliding doors), méthacrylate (ubi: portes coulissantes), methacrylat (ubi: Schiebetüren), methacrylaat (ubi: Schuifdeur), metacrilato (ubi: puerta correddizas)

nero opaco black matt noir mat schwarz matt zwart mat negro mate	grigio grey gris grau grijs gris	bianco opaco white matt blanc mat weiss matt wit mat brillo mate	particolari colore nero black-painted particular items détails en noir detais farbe schwarz detais in zwarte kleur detales de color negro	particolari colore alluminio silver-painted particular items détails en aluminium detais farbe aluminium detais in aluminium kleur detales de color aluminio	particolari colore bianco white-painted particular items détails en blanc detais farbe weiß detais in wit kleur detales de color blanco

tessuto (schermi, ASL: schiena, Kubick), fabric (screen, ASL: back, Kubick), tissu (ecran, ASL: dos, Kubick), stoffe (schirm, ASL: Rückwand, Kubick), stof (schern, ASL: achterwand, Kubick), tejido (pantalla, ASL: respaldo, Kubick)

CAMIRA-LUCIA sabbia-aruba sable-aruba sable-aruba sandfarbe zand-aruba arena-aruba	CAMIRA-LUCIA mattoni-jamaica brick-coloured-jamaica brique-jamaica ziegelrot-jamaica baksteen-jamaica pardo cobre-jamaica	CAMIRA-LUCIA celeste-arecibo light blue-arecibo bleu-arecibo hellblau-arecibo hemelblau-arecibo azul celeste-arecibo	CAMIRA-LUCIA blu-martinique blue-martinique bleu-martinique blauw-martinique azul-martinique	CAMIRA-LUCIA petrolio-windjammer petroleum-windjammer petroleu-windjammer petroleu-windjammer petroleo-windjammer	CAMIRA-LUCIA testa di moro-sombrero dark brown-sombrero brun gris-sombrero donkerbruin-sombrero pardo grisáceo-sombrero	GABRIEL-XPRESS giallo primavera spring yellow jaune printemps frühling gelb lentegeel amarillo primavera	GABRIEL-XPRESS verde sottobosco underwood green vert sous-bois unterholz-groen bosgrond-groen verdes-sootboscoque	GABRIEL-XPRESS blue jeans blue jeans blue jeans denim blue jeans blauw azul denim
PUMA verde mela apple green vert pomme apfelgrün applegroen verde manzana	PUMA grigio scuro dark grey gris foncé dunkelgrau gewoon grijs gris hormigón	PUMA nero black noir schwarz zwart negro	PUMA grigio medio medium grey gris moyen mittelgrau gewoon grijs gris hormigón	PUMA bordeaux bordeaux bordeaux bordeaux burdeos	PUMA blu dark blue bleu blau blauw azul	PUMA bianco white blanc weiß wit blanco	*solo passacavi *only cable holder *seulement passe-câbles *nur kabelführung *alleen kabeldoorvoer *solo pasacables	



EXPERIENCE

Two generations, over 25 years of experience in production with an extensive selection of raw materials



INDUSTRIAL PRODUCTION ABILITY



SELECTION OF RAW MATERIALS

Attention and care in the selection of materials: Wood veneer / glass / leather / fabric / vitro ceramic / Fenix



WARRANTY AND AVAILABILITY OF COMPONENTS:



SPECIAL ITEMS



CERTIFIED PRODUCTION, GREEN ENVIRONMENTALLY AND USER FRIENDLY



PLANNINGS

OUR PRODUCTION SYSTEM FOLLOWS ADVANCED STANDARDS FOR INDIVIDUAL AND NATURE CARE

Our Company operates with the primary objective of guaranteeing products that achieve a correct balance between environmental sustainability and design.



CAM: CRITERI AMBIENTALI MINIMI



Vengono introdotti con l'allegato n. 2 al D.M. dell'11 gennaio 2017 e sono parte integrante del piano d'azione per la sostenibilità ambientale dei consumi della pubblica amministrazione (green public procurement). Le stazioni pubbliche appaltanti sono tenute, pena la nullità, ad introdurre nei documenti di gara «per la fornitura e il servizio di noleggio di arredi per interni» le specifiche tecniche e la clausole contrattuali definite nel documento «criteri ambientali minimi»



Imballi costituiti da materiali facilmente separabili e riciclabili



Riduzione di formaldeide e di sostanze tossiche e potenzialmente dannose



Estensione del ciclo di vita dei prodotti



Produzione di arredi a ridotto impatto ambientale



Facilità di disassemblaggio per favorire la riconfigurabilità, il riutilizzo o il riciclo

BRALCO
YOUR SMART ITALIAN OFFICE

Bralco - Via Luigi Einaudi 1, 31058 Susegana TV - Italy
T +39 0438 437 711 - F +39 0438 437 730
info@bralco.it - www.bralco.it



Edition February 2019